

User Manual

EXTECH
INSTRUMENTS

Model 381295 and 381295-220

**5MHz Dual Channel
True RMS Handheld Oscilloscope**

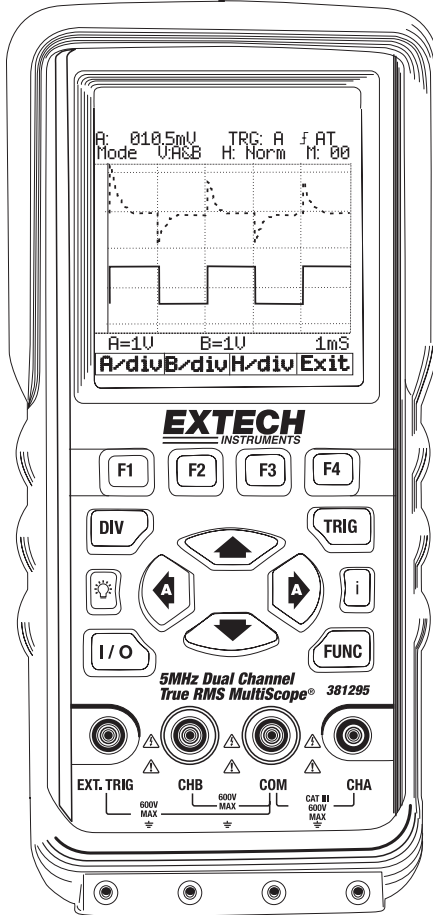

Table of Contents

Introduction	3
Main Features	3
Safety	3
Safety Precautions	3
Safety Symbols	3
Quick-Start Manual	4
Power on and off	4
Division, Trigger and Function key	4
Input Terminals	4
Command (F1-F4), Arrow, Backlight and Help key	4
Primary Menu Map	5
Positioning the waveform on the screen	5
Division key map	6
Changing Vertical (A/div or B/div) division	7
Changing Horizontal division	7
Trigger key map	8
Trigger level control	8
Function key map	9
Specifications	10
General Specifications	10
Oscilloscope Function	11
Digital Multimeter Functions	12
Product Description	14
LCD Area	14
Keys Area	15
Terminal Area	17
Operation	18
Powering the Meter	18
Changing Backlight	18
Making Selections in a Menu	18
Frequency measurements for CHA	19
Freezing the screen	19
Changing the Graphic Representation	20
Acquiring the Waveform	21
Triggering on a Waveform	22
Setting Trigger level (on NORmal trigger mode)	22
Making a single acquisition	23
Setting Trigger mode (Tmode)	23
Setting AUTO Trigger Level	24
Setting Normal Trigger mode	24
Setting Trigger Slope	25
Storing and Recalling Screens	25
Storing Screen	25
Recalling Screen	25
PC Interface and Datalogging Software	26
Maintaining the Meter	29
Battery Replacement.....	259
Appendices	31
Troubleshooting guide	31
Warranty, Repair, and Technical Support	32

Introduction

Main Features

- Rechargeable batteries and AC Adaptor:
Model 381295 (120V, 60Hz)
Model 381295-220 (240V, 50Hz)
- **RS-232C** PC interface for viewing, saving, and printing measurement and waveform data.
- **Dual Channel** operation plus Auto Calibration features.
- **Automatic settings** for horizontal and vertical divisions.
- DC to **5MHz** bandwidth
- Built-in auto ranging **True-RMS** digital MultiMeter
- Auto ranging
- Data hold and run modes.
- Backlit display with Low battery indication.
- Display Type: Super-Twist 132 x 128 pixels.
- Designed to comply with safety standards: UL3111 and CSA C22.2 No.1010-1

Safety

Attention

Carefully read the following safety information before using this instrument.

Safety Precautions









Specific warning and caution statements, where they apply, will be found throughout the manual.

A 'Caution' identifies conditions and actions that may damage the instrument. A 'Warning' identifies conditions and actions that pose hazard(s) to the user.

Symbols used on this instrument and in this manual are explained in the next table.

Warning

To avoid electrical shock, use only the supplied power supply.

	See explanation in manual
	Dangerous Voltage
	Double Insulation (Protection Class)
	Earth (Ground)
	Either AC or DC
	DC – Direct Current
	AC – Alternating Current
	Fuse

Quick-Start

Power On and Off

1. Pressing and holding this button for 2 to 3 seconds will turn the unit on. Pressing this button again will turn the power off.

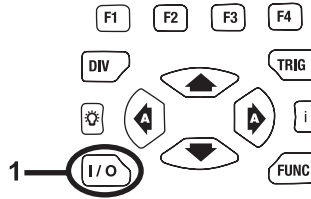

Division, Trigger and Function key

- 1 Division key:**
Adjusts vertical division or Horizontal division.
- 2 Trigger key:**
Adjusts Trigger level.
Selects Single shot mode.
Selects trigger setup.
- 3 Function key:**
Selects Scope Setup.
Selects general setup.

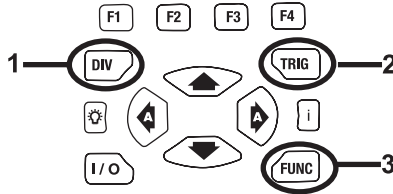

Input Terminals

- 1 Channel A:**
Always use the red channel A input for single input measurements.
- 2 Channel B:**
For measuring two signals, use Channel B with Channel A.
- 3 Common:**
Use the black common as signal ground for low frequency measurements and for ACV, DCV, Ohm, and Continuity measurements.
- 4 External trigger:**
The EXT.TRIG input accepts external trigger signals.

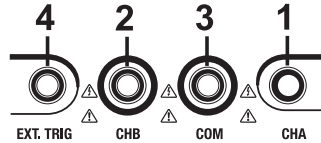

Command (F1-F4), Arrow, Backlight and Help key

- 1 Function Command keys:**
F1 through F4 are command 'soft' keys.
Their functions change with each screen.
- 2 Four arrow keys:**
These keys serve as the primary means of navigating the instrument's menus and operating displays.
- 3 Help key:**
General information for the meter is available with a press of this key.
- 4 Display back light:**
Press this button to turn on the backlight. To turn the back light off, press this button again.

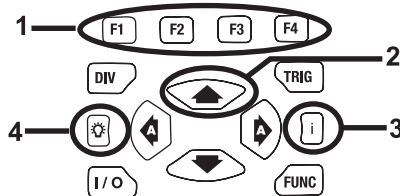

Quick-Start

Primary Menu Map

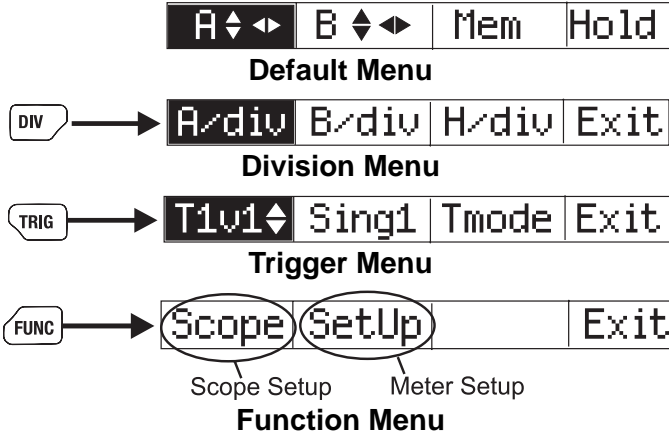

Positioning the Waveform on the Screen

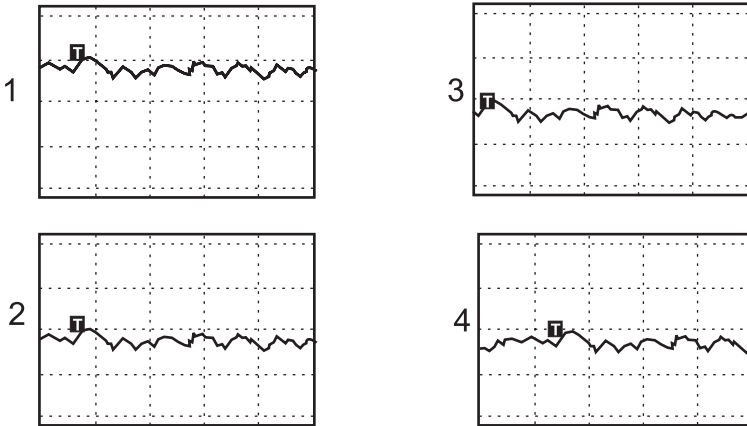

1. Pressing moves the waveform up.
2. Pressing moves the waveform down.
3. Pressing moves the waveform left.
4. Pressing moves the waveform right.

⇒

Quick-Start



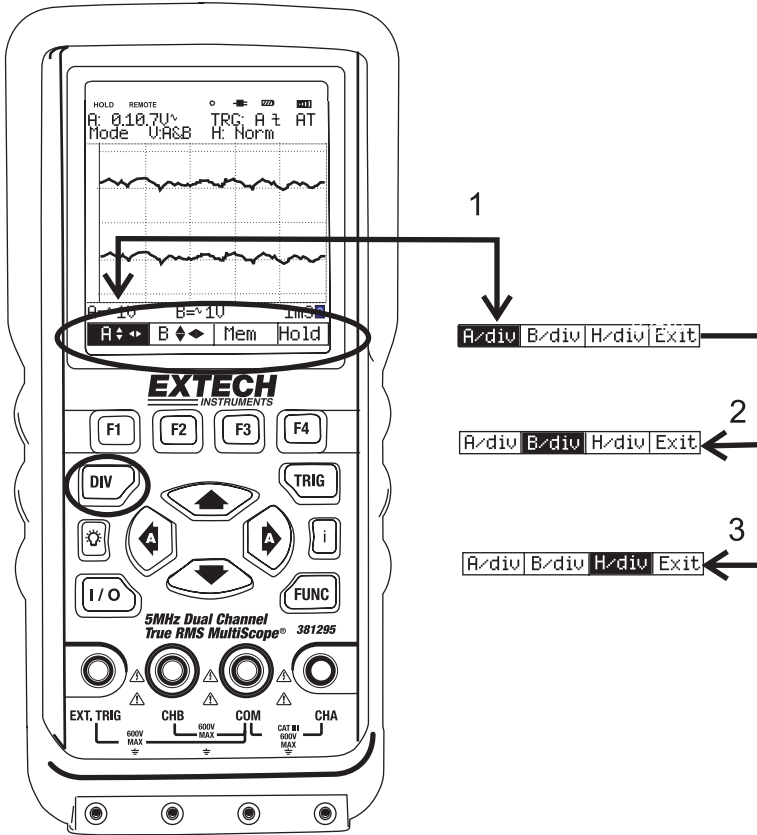

Division key map



- 1 Pressing **DIV** calls up the default division menu.
- 2 Press **F2** to control the Channel B Vertical Division.
- 3 Press **F3** to change the Horizontal Division.
- 4 Press **F4** to exit.



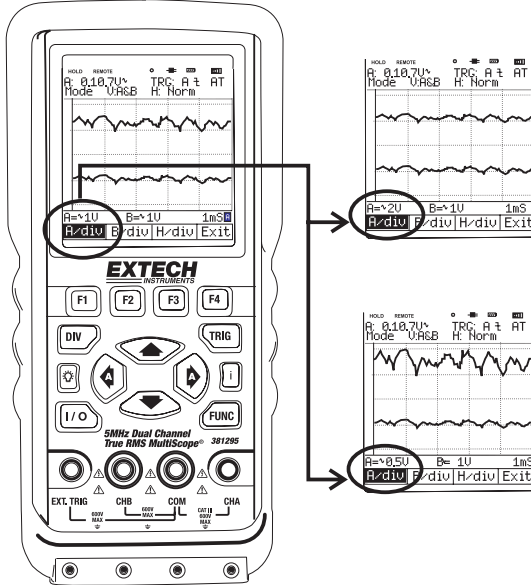

Quick-Start

Changing Vertical (A/div or B/div) division

- 1 Pressing  increases CHA vertical division (A/div).
- 2 Pressing  decreases CHA vertical division (A/div).
- 3 Pressing  or  will change Div from MANUAL to AUTO (A).



Changing Horizontal division

- 1 Pressing  increases Horizontal division (H/div).
- 2 Pressing  decreases Horizontal division (H/div).
- 3 Pressing  or  will change Div from MANUAL to AUTO (A).

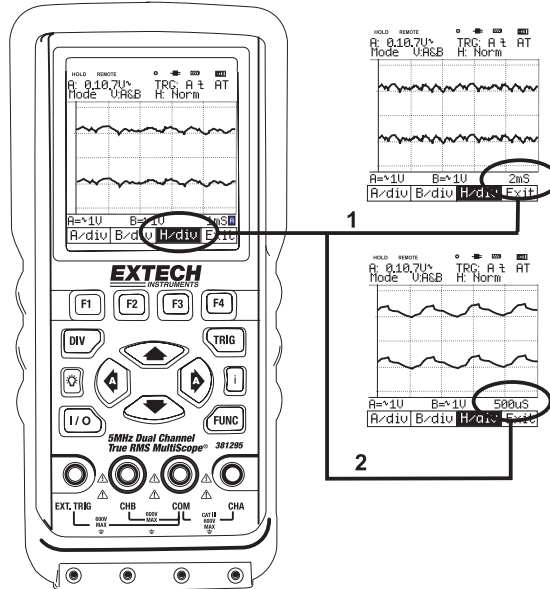

Quick-Start

Trigger key map

- 1 Press **TRIG** to display the TRIGGER default menu.
- 2 Press **F2** for Single shot mode.
- 3 Press **F3** for TRIGGER SETUP.
- 4 Press **F4** to exit.

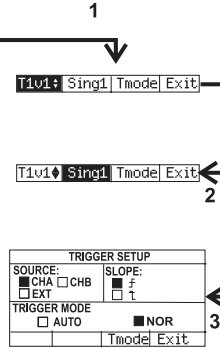
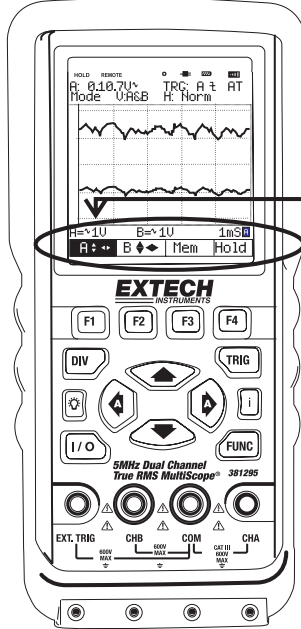

Trigger level control

- 1 Pressing **▲** increases the Trigger level.
- 2 Pressing **▼** decreases the Trigger level.

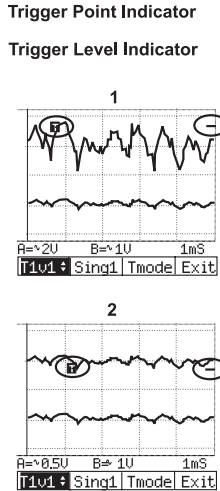
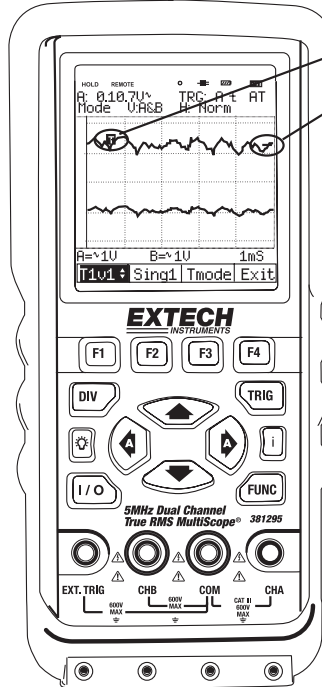

Quick-Start

Function key map

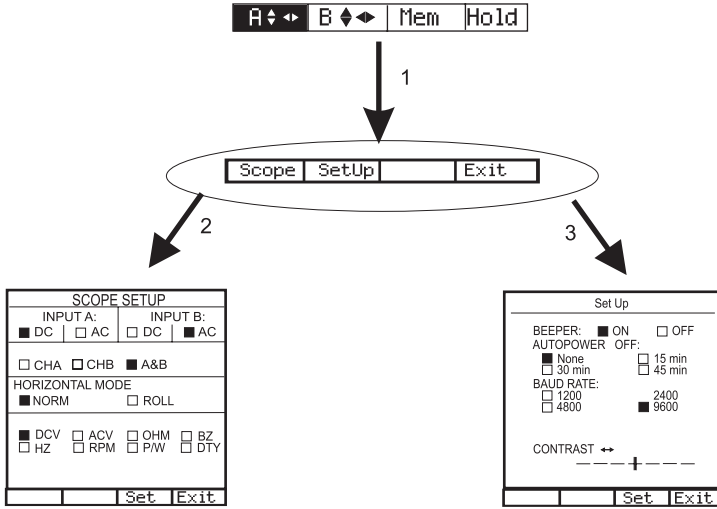

- 1 Press **FUNC** to display the FUNCTION default menu.
- 2 Press **F1** for SCOPE SETUP.
- 3 Press **F2** for General SETUP. Press **F4** to exit.

Specifications

General Specifications

Operational Temperature:	+32°F to +122°F (0°C to +50°C)
Operational Relative Humidity:	< 75%
Storage conditions:	-4°F to 140°F (-20°C to +60°C); < 75%RH
Temperature Coefficient:	0.1 x (Specified Accuracy) per °C for temperature <64.4°F (18°C) to >82.4°F (28°C)
Max. Voltage Input and Ground:	DC or AC 600Vrms
Basic DC Accuracy:	0.3%
Scope Bandwidth:	5 MHz
MultiMeter AC Bandwidth:	20 kHz
Power Supply:	Ni-MH Battery 4.8V (1.2V x 4 cell)
Battery Life:	4 Hours with Backlight OFF, 3 Hours with Backlight ON
Battery Charge Time:	3 Hours approx.
AC Adaptor/Charger:	Class-2 transformer, Input: 120V AC 60Hz (381295) Input: 240V AC 50Hz, (381295-220) Output: 9V DC 1A
Display Type:	Super-Twist 132 x 128 pixels
Equipment Dimensions:	3.5" (90mm) width x 7.7" (195mm) depth x 1.6" (40mm) height
Equipment Weight:	1.0 lbs. (460g) approx.

Oscilloscope Function

Horizontal

Sample Rate	25 MS/s (Dual CH mode) 50 MS/s (Single CH mode)
Record Length	512 single shot mode 256 in all modes
Sample / Division	25
Modes	Single shot, Roll, Normal
Accuracy	0.01%
Sweep Rate	1uS to 5S in 1, 2, 5 sequence

Vertical

Bandwidth	5MHz
Resolution	8 Bit
Channels	Dual
Coupling	AC, DC
Input impedance	1 M Ω
Accuracy	3%
Max. Input Volts	DC or AC 600Vrms
Volts / Division	50 mV to 500V in 1, 2, 5 sequence

Triggering

Type	CHA, CHB, External
Coupling	AC, DC
Slope	Rising (\uparrow) or Falling (\downarrow) edge
Internal Trigger Sensitivity	2 / 20 Division

Waveform Memory

Waveform Memory	16 Screen shots
-----------------	-----------------

Digital MultiMeter Function

DC V

Scope V/Div	DMM Range	Resolution	Accuracy	Impedance
50m,100m,200m	500mV	0.1mV	±(0.3%+3)	1 MΩ
500m, 1, 2	5V	0.001V		
5, 10, 20	50V	0.01V		
50, 100, 200	500V	0.1V	±(0.5%+5)	
500	1000V	1V		

AC V

Scope V/Div	DMM Range	Resol.	Accuracy (Hz)			Imped.
			50~450	0.45k~5k	5k~20k	
50m,100m,200m	300mV	0.1mV	±(0.75%+5)	±(2%+5)	±(2.5%+5)	1 MΩ
500m, 1, 2	3V	0.001V				
5, 10, 20	30V	0.01V				
50, 100, 200	300V	0.1V				
500	750V	1V			N/A	

OHM

Range	Resolution	Accuracy	Over Load Protection
5 kΩ	0.001 kΩ	±(0.5%+5)	600V DC or AC rms
50 kΩ	0.01 kΩ		
500 kΩ	0.1 kΩ		
5 MΩ	0.001 MΩ	±(0.75%+10)	

Continuity Buzzer

Test Voltage	Threshold	Over Load Protection
1.7V	100 digits	600V DC or AC rms

Frequency

Range	Resolution	Accuracy	Overload protection
100 Hz	0.01 Hz	±(0.05%+5)	600V DC or AC rms
1 kHz	0.0001 kHz		
10 kHz	0.001kHz		
100 kHz	0.01kHz		
1 MHz	0.0001MHz		
10 MHz	0.001MHz		

RPM

Range	Resolution	Accuracy
240 - 60,000	1 RPM	$\pm(0.05\%+5)$

Pulse Width

Range
2uS-500mS (Pulse Width > 2uS)

% Duty

Range
25% - 75%

Product Description

In this section, the LCD, front panel buttons, controls and terminals are described.

LCD Area

The screen is divided into five areas: INDICATOR, READING, WAVEFORM, SETTING and MENU areas. Refer to the Figure below.

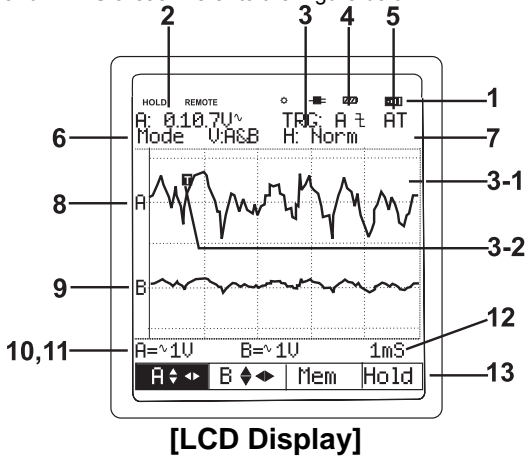

[LCD Display]

1) Indicator

- HOLD: Freezes displayed reading
- REMOTE: RS-232 PC interface indicator
- BACKLIGHT(

2) Primary Numerical Field (DMM Function): Displays numerical readings

3) Trigger selection: Channel A, B and External

3-1) Trigger level indicator

3-2) Trigger Cursor

4) Trigger Slope: Rising or Falling edge

5) Trigger mode: Normal or AUTO

6) Channel mode status

Verticle mode: CHA, CHB, A&B

Horizontal mode: Normal, Roll

7) Memory Address: 0 to 15

8) Live Scope Display (Channel A): Displays real time waveforms and freezes held captures.

9) Channel B

10) Channel A Vertical Division

11) Channel B Vertical Division

12) Horizontal Division (Time base)

13) Command Menu Field

Keys Area

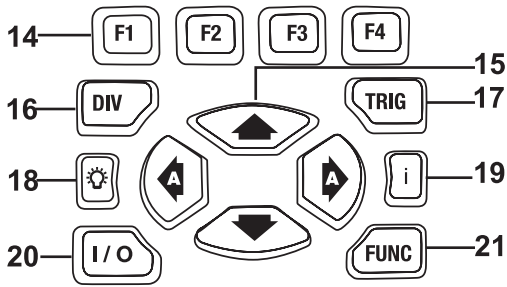

- 14) Command Menu keys
The F1 – F4 soft keys' functions change with each display screen.

Default (Command Menu)

A/div	B/div	H/div	Exit
F1	F2	F3	F4

- 15) Arrow keys: Use the arrow keys to highlight an item.
- ▲ Press to move the cursor upward. This button also increases the value of a selection.
 - ▼ Press to move the cursor downward. This button also decreases the value of a selection.
 - ◀ Move the cursor to the left with this button.
Pressing this button changes Vertical division or horizontal division from MANUAL to AUTO.
 - ▶ Move the cursor to the right with this button.
Pressing this button changes Vertical division or horizontal division from MANUAL to AUTO.

- 16) **DIV** Division key: Set Channel A and B Horizontal Division

A/div	B/div	H/div	Exit
F1	F2	F3	F4

7) **TRIG** Trigger key: Set Trigger level, Single mode and Setup

F3

Tlvl	Singl	Tmode	Exit
F1	F2	F3	F4

TRIGGER SETUP			
SOURCE: <input checked="" type="checkbox"/> CHA <input type="checkbox"/> CHB <input type="checkbox"/> EXT		SLOPE: <input type="checkbox"/> f <input checked="" type="checkbox"/>	
TRIGGER MODE: <input type="checkbox"/> AUTO <input checked="" type="checkbox"/> NOR			
		Set	Exit
F1	F2	F3	F4

- 18) Back Light Key: Activates Back Light for the LCD, Toggles backlight ON and OFF.
- 19) Help key: Provides meter model number, firmware version, serial number, calibration date and manufacture date.
- 20) **I/O** Power switch: Turns the instrument ON or OFF (hold for 3 seconds to turn on)
- 21) **FUNC** Function Key: Set Scope, Auto Scope and Setup of the METER

Scope	Setup		Exit
F1	F2	F3	F4

Scope Setup
FUNC→F1 (Scope)

SCOPE SETUP			
INPUT A: <input checked="" type="checkbox"/> DC <input type="checkbox"/> AC		INPUT B: <input checked="" type="checkbox"/> DC <input type="checkbox"/> AC	
VERTICAL MODE: <input type="checkbox"/> CHA <input type="checkbox"/> CHB <input type="checkbox"/> A&B			
HORIZONTAL MODE: <input checked="" type="checkbox"/> NORM <input type="checkbox"/> ROLL			
MEASUREMENTS A: <input checked="" type="checkbox"/> DCV <input type="checkbox"/> ACV <input type="checkbox"/> OHM <input type="checkbox"/> BZ <input type="checkbox"/> HZ <input type="checkbox"/> RPM <input type="checkbox"/> P/W <input type="checkbox"/> DTY			
		Set	Exit
F1	F2	F3	F4

Terminal Area



22) Terminals description

The METER provides 4 input jacks.

① CHA: Channel A

Use the red channel A terminal for all single input measurements.

② COM: Common

Use the black COMMON terminal as signal ground for DCV, ACV, Ohm, Continuity, frequency and RPM measurements.

③ CHB: Channel B

When measuring two signals, use channel B and channel A.

④ EXT. TRIG

External trigger.

Operation

Powering the METER

Follow the steps below to power the Meter from a standard ac outlet.

1. Insert Power Adaptor into AC outlet.
2. Connect the Power Adaptor to the Meter.
3. **I/O** Turn the Meter on by holding this button for about 3 seconds.
4. The meter powers up configured as it was at last power down.

Changing Backlight

1. Press  Backlight ON.
2. Press  Backlight OFF.

Note: Using the meter without the backlight increases battery life by 1 hour approximately.

Selecting items in a Menu

Follow steps ① through ⑤ to open a menu and choose an item.

Press **FUNC** to open the FUNCTION menu.

Scope	SetUp		Exit
F1	F2	F3	F4

Press **F1** to open the **Scope Setup** menu.

SCOPE SETUP			
INPUT A: ■ DC □ AC		INPUT B: ■ DC □ AC	
VERTICAL MODE: □ CHA □ CHB ■ A&B			
HORIZONTAL MODE: ■ NORM □ ROLL			
MEASUREMENTS A: ■ DCV □ ACV □ OHM □ BZ □ HZ □ RPM □ P/W □ DTY			
		Set	Exit
F1	F2	F3	F4

Use the  arrow keys to highlight an item

Press **F3** to select an item

Press **F4** to Exit

Frequency measurement for CHA:

Plug the black test lead into the COM input jack and plug the red test lead into the CHA input jack

Press **FUNC** to open the FUNCTION menu.

Scope	SetUp		Exit
F1	F2	F3	F4

Press **F1** to open the Scope Setup menu.

SCOPE SETUP			
INPUT A:		INPUT B:	
<input checked="" type="checkbox"/> DC	<input type="checkbox"/> AC	<input checked="" type="checkbox"/> DC	<input type="checkbox"/> AC
VERTICAL MODE:			
<input type="checkbox"/> CHA	<input type="checkbox"/> CHB	<input type="checkbox"/> A&B	
HORIZONTAL MODE:			
<input checked="" type="checkbox"/> NORM	<input type="checkbox"/> ROLL		
MEASUREMENTS A:			
<input checked="" type="checkbox"/> DCV	<input type="checkbox"/> ACV	<input type="checkbox"/> OHM	<input type="checkbox"/> BZ
<input type="checkbox"/> HZ	<input type="checkbox"/> RPM	<input type="checkbox"/> P/W	<input type="checkbox"/> DTY
		Set	Exit

Press  to Highlight Hz (Hz)



F3 Set
F4 Exit

Observe that Hz is now the main reading.



Holding (freezing) the display screen

You can freeze the screen (all readings and waveforms) at any time.



Default (Command Menu) Display:

A 	B 	Mem	Hold
F1	F2	F3	F4

F4 freeze the screen. Highlighted Hold appears at the bottom of the Command Menu area.

A 	B 	Mem	Hold
F1	F2	F3	F4

F4 Resume your measurement

A 	B 	Mem	Hold
F1	F2	F3	F4

Changing the Graphic Representation

Changing the vertical division

DIV Open the Command Menu.

A/div	B/div	H/div	Exit
F1	F2	F3	F4

F1 or **F2** Change the vertical division. (CH A or CH B)

▲ Increase the vertical division, Div is changed to manual mode

▼ Decrease the vertical division, Div is changed to manual mode.

▲ or ▼ Change Div from Manual mode to AUTO mode

Changing the Time Base

DIV Open the Command Menu.

A/div	B/div	H/div	Exit
F1	F2	F3	F4

F3 Change the Horizontal division

A/div	B/div	H/div	Exit
F1	F2	F3	F4

▲ Increase the number of periods.

Div is changed to manual mode

▼ Decrease the number of periods.

Div is changed to manual mode

▲ or ▼ Change Div from Manual mode to AUTO mode

Acquiring the Waveform

FUNC Open the FUNCTION menu.

Scope	SetUp		Exit
F1	F2	F3	F4

F1 Open the Scope Setup menu.

SCOPE SETUP			
INPUT A:		INPUT B:	
<input checked="" type="checkbox"/> DC	<input type="checkbox"/> AC	<input checked="" type="checkbox"/> DC	<input type="checkbox"/> AC
VERTICAL MODE:			
<input type="checkbox"/> CHA	<input type="checkbox"/> CHB	<input type="checkbox"/> A&B	
HORIZONTAL MODE:			
<input checked="" type="checkbox"/> NORM		<input type="checkbox"/> ROLL	
MEASUREMENTS A:			
<input checked="" type="checkbox"/> DCV	<input type="checkbox"/> ACV	<input type="checkbox"/> OHM	<input type="checkbox"/> BZ
<input type="checkbox"/> HZ	<input type="checkbox"/> RPM	<input type="checkbox"/> P/W	<input type="checkbox"/> DTY
		Set	Exit
F1	F2	F3	F4

Recording Slow Signals over a Long Period of Time



Highlight ROLL MODE.

F3 Set ROLL MODE.

F4 Exit.

The roll mode function supplies a visual log of waveform activity and is especially useful when measuring lower frequency waveforms.

Note: ROLL MODE operates when the horizontal division is between 1s and 5s

Selecting AC-Coupling for INPUT A



Highlight AC for INPUT A.

F3 SET

F4 Exit.

Triggering on a Waveform

Triggering tells the Meter when to begin displaying a waveform. The instructions that follow explain how to:

- Select a Channel
- Select rising or falling edge on which to trigger
- Define the condition for a new update of the waveform.

The display icons on the top line (right side) of the LCD identify the trigger parameters currently used. Trigger icons on the screen indicate the trigger level and slope.

- (1) Trigger Channel: Channel A or B
- (2) Slope: rising or falling
- (3) Trigger mode: Trigger setting mode (Auto or Normal)
- (4) Trigger Level indicator
- (5) Trigger Cursor
- (6) Command Menu: Trigger level
- (7) Command Menu: Single shot
- (8) Command Menu: Trigger mode (Setup)

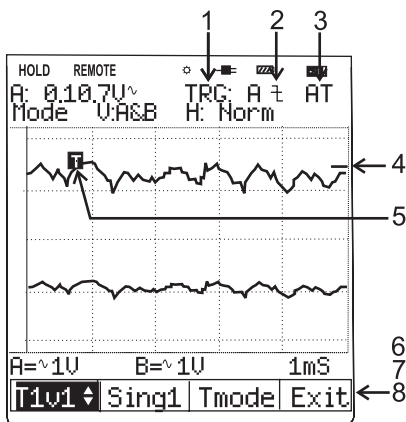

Setting Trigger level (on NORmal trigger mode)

TRIG Open the Trigger menu

Trig	Singl	Tmode	Exit
F1	F2	F3	F4



Adjust the Trigger Level continuously. Observe the horizontal trigger icon on the rightmost time division line.

F4 Exit.

Making a single acquisition

To catch single events, perform a single shot. (One time screen update.) To set up the Meter for a single shot on the input Channel A waveform: Connect the probe to the signal to be measured.

TRIG Open the Trigger menu

TIV 	Singl	Tmode	Exit
F1	F2	F3	F4

F2 Highlight Singl (SINGLE SHOT)

TIV 	Singl	Tmode	Exit
F1	F2	F3	F4

Meter performs a single shot. (One time screen update)



F2 Return to normal Trigger mode.

Setting Trigger mode (Tmode)

TRIG Open the Trigger menu

TIV 	Singl	Tmode	Exit
F1	F2	F3	F4

F3 Open the Trigger Setup

TRIGGER SETUP			
SOURCE: <input checked="" type="checkbox"/> CHA <input type="checkbox"/> CHB <input type="checkbox"/> EXT		SLOPE: <input type="checkbox"/>  <input checked="" type="checkbox"/> 	
TRIGGER MODE: <input type="checkbox"/> AUTO <input checked="" type="checkbox"/> NOR			
		Set	Exit
F1	F2	F3	F4



Highlight an ITEM.

F3 Set the ITEM.

F4 Exit.

Setting AUTO Trigger Level

For fast trigger operation, use the AUTO trigger mode to trigger on nearly all signals automatically. To optimize the trigger slope manually:

F3 Open the Trigger Setup

TRIGGER SETUP			
SOURCE: <input checked="" type="checkbox"/> CHA <input type="checkbox"/> CHB <input type="checkbox"/> EXT		SLOPE: <input type="checkbox"/> f <input checked="" type="checkbox"/> z	
TRIGGER MODE: <input type="checkbox"/> AUTO <input checked="" type="checkbox"/> NOR			
		Set	Exit
F1	F2	F3	F4



Highlight AUTO.

F3 Set AUTO.

F4 Exit.

Setting Normal Trigger mode



Highlight NOR.

F3 Set NOR.

F4 Exit.



Adjust the Trigger Level continuously. Observe the horizontal trigger icon on the rightmost time division line.



Setting Trigger Slope



Highlight  or .

F3 Set  or .

F4 Exit.



 or  Trigger on either positive Slope or negative Slope of the chosen waveform.

Storing and Recalling Screens

The meter can store setups and waveforms to memory for later recall. Sixteen (0-15) setup and waveform memories are available.

Storing a Screen

F3 Open the memory (Mem) menu

Sto 	Rcl 		Exit
F1	F2	F3	F4

Memory field (M:00) appears at the top-right corner of the display area.

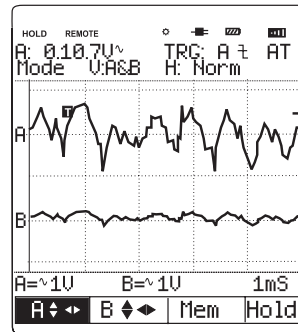

 Select the memory address where the screen is to be stored.

F1 Store the actual screen



Recalling Screen

F3 Open the memory menu

Sto 	Rcl 		Exit
F1	F2	F3	F4

Memory field (M:00) appears at the top-right corner of the display area.

 Select the memory address from which to recall the screen.

F2 Recall the screen.

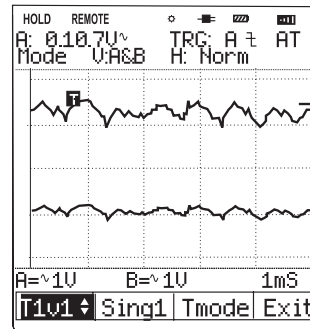

PC Interface and Datalogging Software

Introduction

With the Meter connected to a PC, measurements can be viewed on the computer screen as they are taken. Graphical (scope) as well as numerical (DMM) data can be viewed. Measurement data can then be stored in a file and/or printed. Data files can be opened in spreadsheets as 'text files' if desired. The PC interface also allows the meter to be remotely controlled using the on-screen virtual push-buttons.

Connecting the Meter to a PC

Connect the meter to the PC using the supplied communication cable. The TRS (tip/ring/sleeve phono plug) end of the cable connects to the meter (top) and the 9-pin end connects to the PC serial port.

Installing the Supplied Datalogging Software

Install the software by placing the supplied diskette in the PC floppy drive. Run the SETUP.EXE file from the list of files on the diskette. Follow the on-screen instructions for installation. The supplied software should be installed on the PC hard drive first and the program should be launched from the version on the hard drive. Do not run the software program straight from the supplied disk.

Main Software Screen

After the program is installed, open the program to view the main software screen:

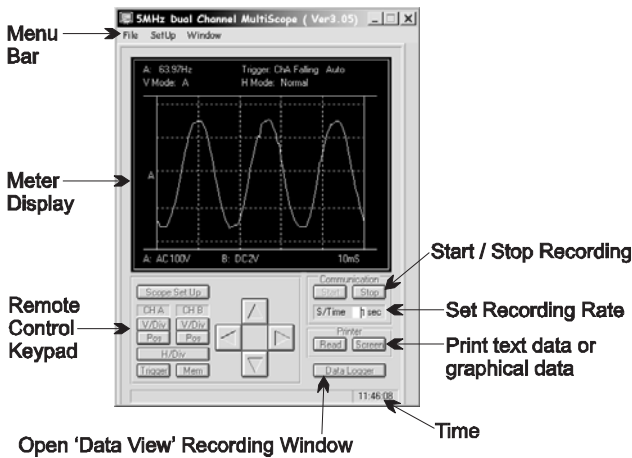

Menu Bar in Main Software Window

The Menu Bar includes FILE, SETUP, and WINDOW selections, explained below:

FILE

Under FILE click on EXIT to close the program

SETUP

Under SETUP select COMM to choose the PC COMM port and the baud rate. Select PRINTER to configure the line printer. Select COLOR to choose the display color configuration.

WINDOW

Select DATALOGGER to open the Data View recording window (see below)

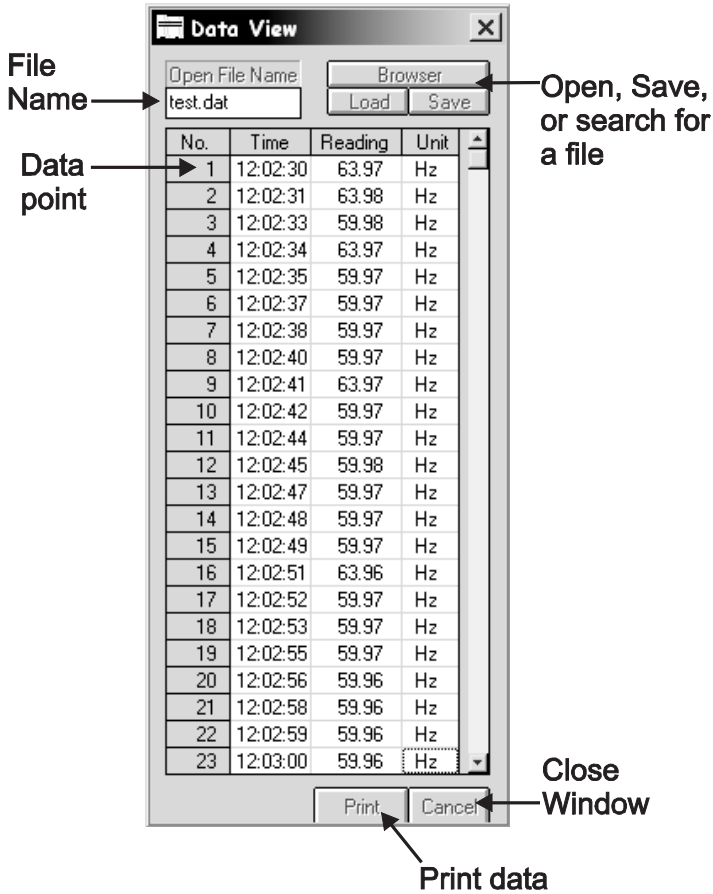

Communicating with the PC

Once the program is running and the meter is connected, shut the meter off and turn it back on. This will initiate communication between the meter and PC.

Under the SETUP menu on the main software screen, select the appropriate Serial Comm Port and Baud Rate and then click the OK button.

To select the sampling time (rate at which data points are recorded), click on the S / TIME button and type the desired sampling time.

Open the Data View window by clicking the DATA LOGGER button on the main software screen. Click the **"START"** button to begin recording. Press **'STOP'** to end recording. The data points should appear in the Data View window. If not, check that the proper COMM PORT is selected under SETUP.

Once the datalogger is started and the data points are appearing in the Data View window, the software program's remote control virtual pushbuttons can be used.

Data View Window Operation

In the Data View window (shown above), the data points can be stored in a file using the SAVE button. When the SAVE button is RED the program is storing readings in the file shown in the OPEN FILE NAME field. Click on the SAVE button until the letters appear in red, the readings are now being stored. When the SAVE button is not RED, readings can still be viewed in the data list but the readings are not being saved.

To open a file of previously stored data, use the BROWSER button. When the file is found and opened, use the LOAD button to recall the data points to the Data View Window.

Maintaining the Meter

Cleaning the Meter

Clean the Meter with a damp cloth and a mild soap. Do not use abrasives, solvents, or alcohol.

Storing the Meter

If you are storing the Meter for an extended period of time, charge the NI-MH battery pack before storing. It is not necessary to remove the battery pack.

Replacing and Disposing of the NI-MH Battery Pack

Warning

To avoid electrical shock, remove the test leads and probes before replacing the battery pack.

Note

This instrument contains a NI-MH battery pack. Do not dispose of this battery pack with other solid waste. Used batteries should be disposed of by a qualified recycler or hazardous materials handler.

To replace the battery pack:

1. Disconnect the test leads and probes both at the source and at the meter.
2. Loosen the screws with a screwdriver.
3. Lift the rear cover away from the Meter.
4. Take the battery pack out of the battery compartment.
5. Remove the battery plug from the connector.
6. Install a new battery pack.
7. Reinstall the rear cover and secure the screws.

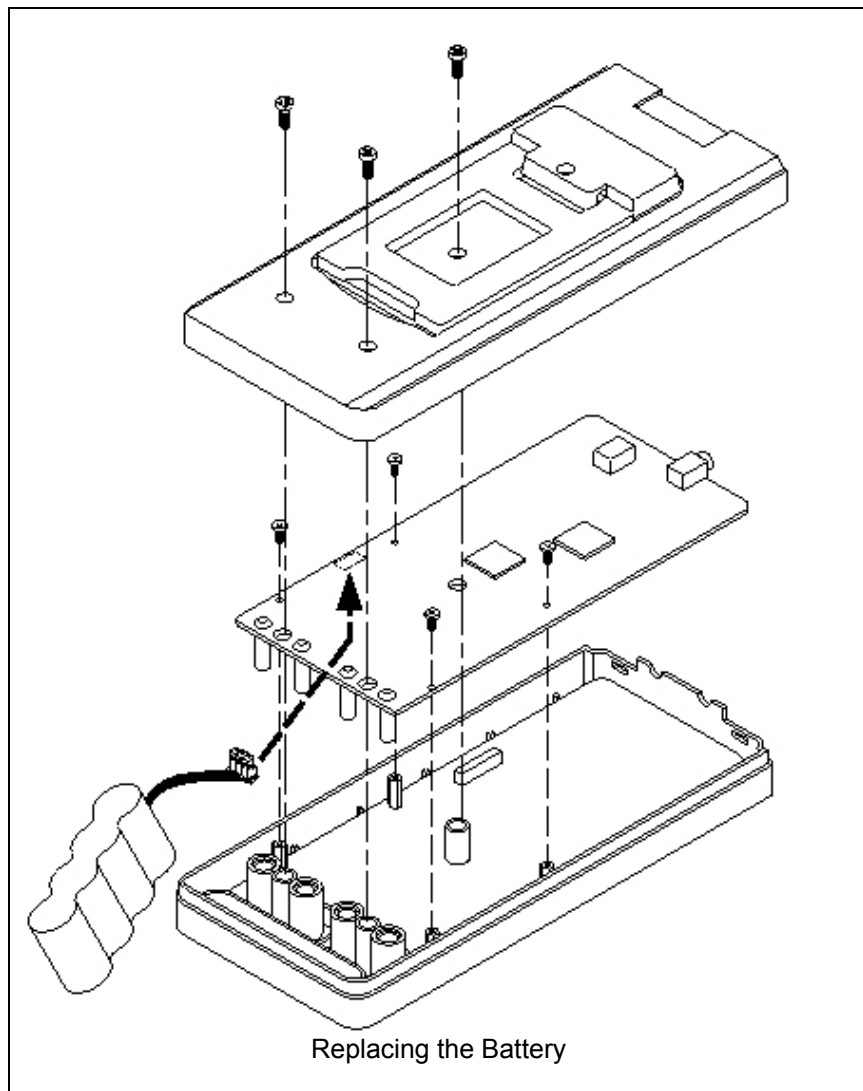

Troubleshooting guide

If you experience a problem with the meter, try the corrective actions below before concluding that the instrument needs repair.

1. Make sure you are using a fresh NI-MH battery pack or fully charged rechargeable battery pack. If you are using the AC/DC power adapter, make sure the adapter is plugged into an appropriate live power source.
2. If the buttons do not respond or the contrast is set such that the display is unreadable, remove the power source while the instrument is on. Wait 15 minutes and then restore power and retry.
3. If you still experience difficulty, check your connections and reread this instruction manual.
4. If the meter's display is frozen when trying to control the trigger level:
 - In normal (NOR) mode, the trigger level must be the same level as the waveform. The Meter does not trigger if the trigger level is set above or below the waveform level.
 - In Auto (AT) mode, the trigger level does not have to be adjusted.
 - In rare cases, the instrument may require servicing. There are no internal user-serviceable parts.

Warranty, Repair, and Technical Support

Warranty

EXTECH INSTRUMENTS CORPORATION warrants this instrument to be free of defects in parts and workmanship for **one year** from date of shipment (a six month limited warranty applies to sensors and cables). If it should become necessary to return the instrument for service during or beyond the warranty period, contact the Customer Service Department at (781) 890-7440 ext. 210 for authorization or visit our website www.extech.com for contact information. A Return Authorization (RA) number must be issued before any product is returned to Extech. The sender is responsible for shipping charges, freight, insurance and proper packaging to prevent damage in transit. This warranty does not apply to defects resulting from action of the user such as misuse, improper wiring, operation outside of specification, improper maintenance or repair, or unauthorized modification. Extech specifically disclaims any implied warranties or merchantability or fitness for a specific purpose and will not be liable for any direct, indirect, incidental or consequential damages. Extech's total liability is limited to repair or replacement of the product. The warranty set forth above is inclusive and no other warranty, whether written or oral, is expressed or implied.

Calibration and Repair Services

Extech offers repair and calibration services for the products we sell. Extech also provides NIST certification for most products. Call the Customer Service Department for information on calibration services available for this product. Extech recommends that annual calibrations be performed to verify meter performance and accuracy.



Support line (781) 890-7440

Technical support: Extension 200; E-mail: support@extech.com

Repair & Returns: Extension 210; E-mail: repair@extech.com

Product specifications subject to change without notice

For the latest version of this User's Guide, Software updates, and other up-to-the-minute product information, visit our website: www.extech.com
Extech Instruments Corporation, 285 Bear Hill Rd., Waltham, MA 02451

Copyright © 2005 Extech Instruments Corporation

All rights reserved including the right of reproduction in whole or in part in any form.