



D550

SHAFT ALIGNMENT

For alignment work in explosive environments (ATEX/EX)



FOR EXTREME ENVIRONMENTS

Easy-Laser® Extreme™ is one of the toughest and most robust measurement and alignment systems on the market for potentially explosive areas. For alignment work in potentially explosive environments, equipment needs to be explosion-protected. This applies to all equipment that can create one or more of a number of different specific explosion sources, such as *Chemical reactions, Static electricity, Electrical sparks, Mechanical knocks, Mechanical friction*, etc. Easy-Laser® Extreme™ complies with the latest ATEX standards for work in such environments.

With Easy-Laser® Extreme™ we have gone one step further. The entire construction is extremely durable with regard to external influences, not just impact-resistant, but also resistant to corrosion and leaks. This is because we know that measurement systems are all too often used in environments that are anything but clean and dry. This could involve anything from water to oil or solvents. The measurement system is therefore naturally IP67 approved.

Viewed as a whole, with its robust construction, its software and its generous guarantee period, you get a measurement and alignment system that is extremely hard to beat!



ATEX APPROVED – Easy-Laser® Extreme™ is approved in accordance with the latest ATEX directive.
EX certificate number: Nemko 06ATEX1051X
ATEX code: II 2 G, EX classification: EEx ib IIC T4
II=Indicates that the instrument is approved for all areas except mines 2=Unit category. Intrinsically safe equipment for zones 1 and 2 (likely occurrence of explosive atmosphere)
G=Indicates atmosphere: Gas, Vapours, Mists
EEx=Explosion protection based on European standards
ib=Type of protection from an explosion
IIC=Explosion group
T4=Temperature class



IP67 APPROVED – Easy-Laser® Extreme™ is waterproof, dust-proof and shockproof. The instrument has been tested and approved in accordance with *Ingress Protection Rating System* IP67, which means that the system is dustproof and waterproof to a depth of 1 metre.



4-YEAR WARRANTY



0470



EXTREMELY DURABLE – The construction of all parts of the measurement system complies with our Extreme™ concept: rustproof and hard anodised materials for maximum corrosion resistance, stronger instrument housing and impact protection for connectors.



Intrinsically safe products are used in a number of industries: Petrochemical, Oil/Gas, Refineries, Pharmaceutical, Paper mills, Bulk materials such as grain, fertiliser, sugar and salt mills, diverse Chemical industries such as the manufacture of Dyes and Bleaches. The list goes on and on.



Easy-Laser® Extreme™ is waterproof, dustproof and shockproof. Together with its extra-strong construction and its high corrosion resistance, this guarantees many years of problem-free use in the toughest environments.

A COMPLETE MEASUREMENT SYSTEM

Easy-Laser® Extreme™ is a measurement and alignment system for rotating machinery such as motors and pumps, turbines, compressors, gearboxes, blowers, etc.

In addition to shaft alignment programs, there are also programs for measuring straightness and twisting of foundations, for example. This means that the system is extremely suitable both for the establishment of new installations and for continuous maintenance work.

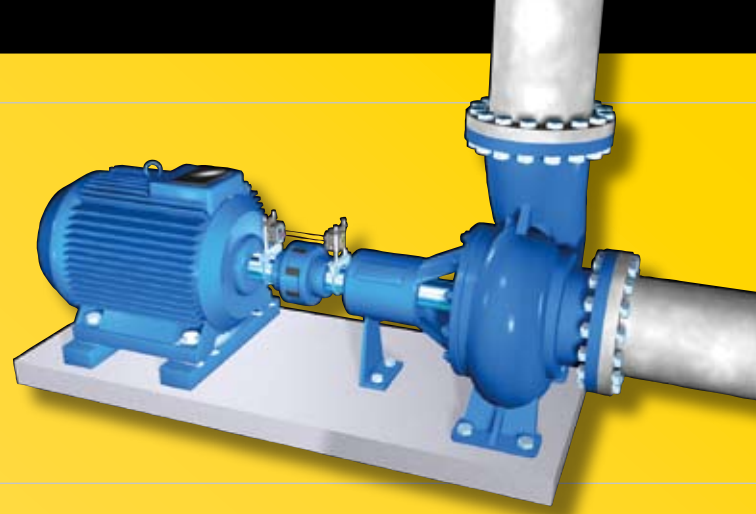

MEASUREMENT PROGRAMS AND FUNCTIONS

The key to quick and easy measurements is a measurement program that helps you achieve your best. We have therefore included a large number of measurement programs in the display unit as standard. All measurement programs guide the user through the entire measurement process step by step. So you can leave most of the thinking and all the difficult calculations to the measurement system.



EASYTURN™ - For alignment of horizontal machines. Allows complete measurement with only 40° rotation of the shafts.



HORIZONTAL - For alignment of horizontal machines in accordance with the 9-12-3 method.



SOFTFOOT - With this program you can check that the machine is resting on all feet. Shows which foot should be corrected.



THERMAL GROWTH COMPENSATION - Compensates for difference in thermal expansion between the machines. Sub-function.



TOLERANCE CHECK - Checks the readings for offset and angle against the selected tolerance. Graphic representation on the screen when the alignment is within the tolerance values. Sub-function.



MEASUREMENT VALUE FILTER - Advanced electronic filter function for a reliable measurement result even in a poor measurement environment, e.g. where there is air turbulence or high vibrations. Sub-function.



CARDAN - Shows angular errors and adjustment value on cardan-shaft-coupled/centre-offset machines. (Requires accessory fixtures.)



VERTICAL - For measurement of vertical and flange-mounted machines.



MACHINE TRAIN - For the alignment of two to ten machines in a row (nine couplings). The entire alignment process can be followed live on the screen.



REFLOCK™ - Any pair of feet can be locked/set as a reference. This is a sub-function in the Machine train program.



OFFSET AND ANGLE - Shows centre offset and angular error between, for example, two shafts. Also suitable for dynamic measurements.



VALUES - Shows live readings from S and M unit. Can be used for shaft alignment, straightness measurement and dynamic measurement.



STRAIGHTNESS - For measuring straightness of machine foundations, shafts, bearing journals, etc. Can handle up to 150 measurement points with two zero points.

DOCUMENTATION OF MEASUREMENT RESULTS

Once measurements are complete, you have several options for documenting the results. Choose the one that is most suitable for the situation, depending, for example, on whether further analysis is needed or whether a measurement report must be produced. The keyboard with all characters accessible makes it simple to give each measurement a unique description.



Your description

SAVE IN THE DISPLAY UNIT

You give each measurement a unique description. The system then adds the time and date of the measurement. Up to 1,000 shaft alignments can be saved.



PRINTOUT

If you want to document the alignment without using a PC, just connect up a printer and print out all measurement data. (A printer is an accessory and is not approved for explosive environments.)

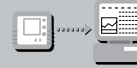
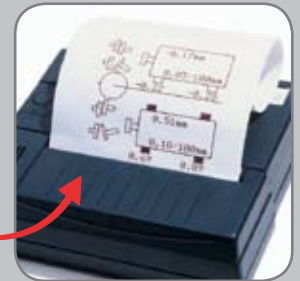

TRANSFER MEASUREMENT DATA TO PC

With the EasyLink™ program for Windows® (included), you can produce professional reports using both measurement data and pictures and export to spreadsheets such as Excel®, etc. Connection is via RS232 or USB.



Excel® sheet with pictures

SIMPLE MEASUREMENT PROCEDURE

The measurement procedure is simple. You are guided step by step through the measurement process. "Live" values are used for adjustment of the machine. Documentation can be produced before and after alignment. The section below shows how alignment of a motor and pump can be performed using the EasyTurn™ program for horizontal machines.

1. WHAT THE PROGRAM NEEDS TO KNOW

The only thing you need to tell the measurement program is the distances between measuring units and machine feet. The rest is done by the measurement system. Simple!

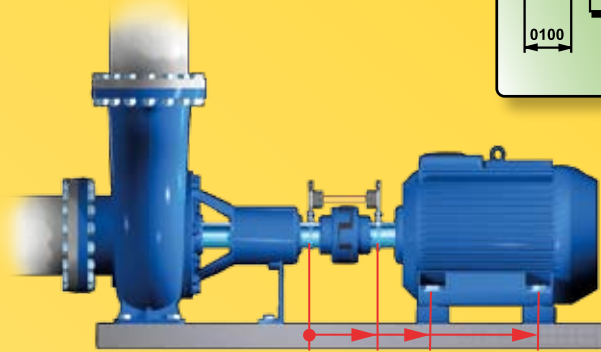
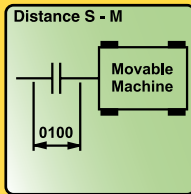

2. SOFTFOOT CHECK

Start by performing a softfoot check to ensure the machine is resting evenly on all its feet. This is necessary for a reliable alignment.

After the softfoot check you can go direct to the alignment program with all of the machine's distances saved.

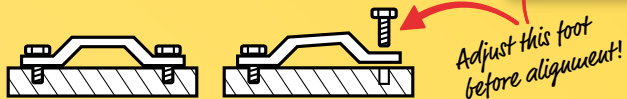
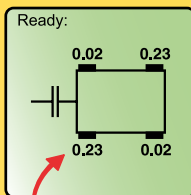

3. SIMPLE MEASUREMENT PROCEDURE

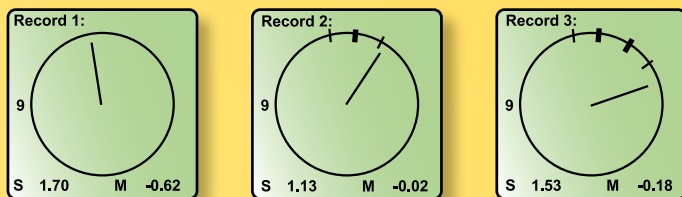

Turn the shafts with measuring units to three positions. With the EasyTurn™ program you can start anywhere on the turn.

Press the Enter button at each position to record the value.

The measurement is ready!

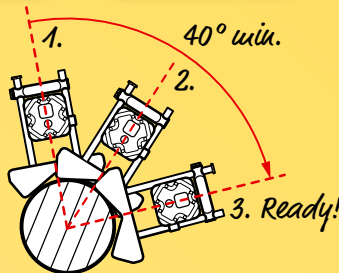

(The Horizontal program measures in three fixed positions 9-12-3. Can be used, for example, on ships at sea, where the built-in inclinometers can not be used.)

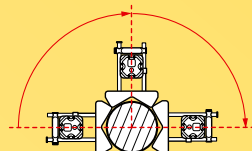

4. THE RESULT IS CLEARLY DISPLAYED

Offset, Angular values and Shim and Adjustment values are clearly displayed. Both horizontal and vertical values are shown "live", making it simple to adjust the machine.

A. Offset value B. Angular value
C. Shim/Adjustment value. Live direction is indicated by filled machine foot symbols.

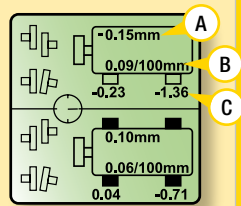

VERTICALLY

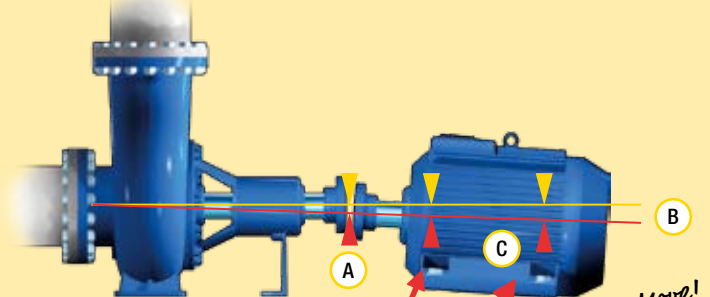

HORIZONTALLY

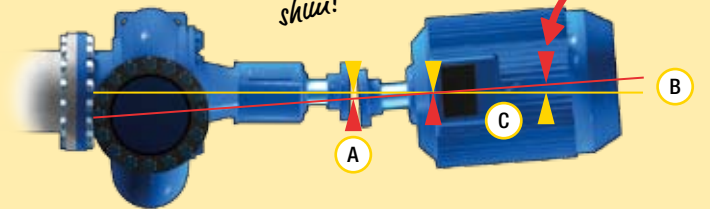

5. TOLERANCE CHECK

Measurement results can be checked against pre-defined tolerance tables or values you determine yourself. In this way, you can see immediately whether the alignment is within the approved tolerances. This means the times for alignment are shortened considerably.

D. Tolerance setting menu. Select speed range or specify your own values.

E. Filled coupling symbols are displayed once the machine has been aligned within the tolerances.

TOLERANCES	
Speed	0-1000 rpm
Offset	0.09 mm
Angle	0.09 mm/100mm

D

< more >

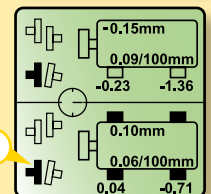

6. COMPENSATION FOR THERMAL GROWTH

In many cases, the machines in this example, the pump and the motor, expand considerably from a cold to a hot state (operating temperature). Using the Thermal Growth Compensation function, the measurement system calculates the correct shim and adjustment values even in these cases. The compensation values for the various machines are normally supplied by the manufacturers.

Vertical Offset	
Set The Value	
	0.1 mm
Comp. Therm Growth	

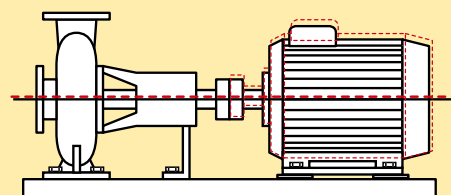

7. DOCUMENT THE MEASUREMENT RESULT

MACHINE TRAIN

In addition to the Horizontal and EasyTurn™ programs, there are a number of specially adapted programs, such as Machine train, which is used for the alignment of two to ten machines in a row. Features the RefLock™ function, meaning that you can choose any two pairs of feet as locked (references). For example, the values for the first and last pairs of feet in the entire machine train can be locked, and can act as the references to which the other machines are adjusted. Can also be used when you have only two machines to align and you want to be able to choose which is to be used as stationary and which as adjustable once measurement is complete.

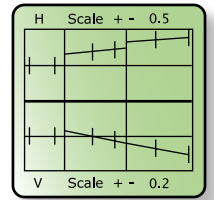
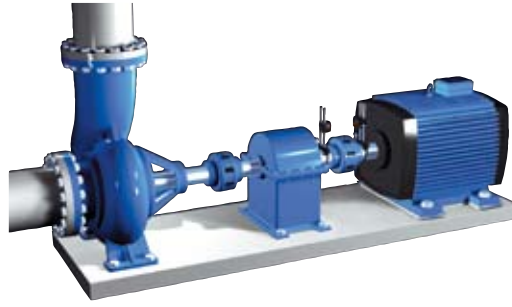

VERTICAL/FLANGE-MOUNTED MACHINES

This program is used for the alignment of vertical and flange-mounted machines. Shows centre offset, angular error and shim value at each bolt.

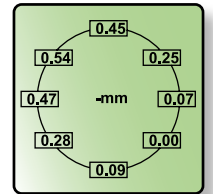
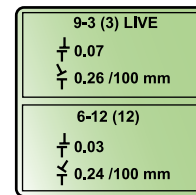

CARDAN-SHAFT-COUPLED MACHINES

The Cardan program is used for the alignment of cardan-shaft-coupled/centre-offset machines. (Requires accessory *Cardan fixture*.)

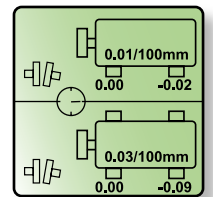
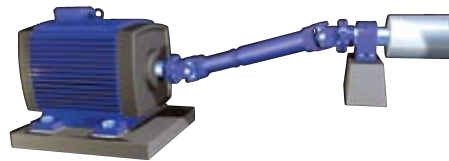

OFFSET AND ANGLE

This program shows centre offset and angular error between two rotating shafts, for example, machine spindles in automatic drilling machines and machine tools, as well as propeller shafts. The program is also ideal for dynamic measurements.

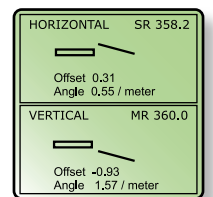

STRAIGHTNESS/TWIST MEASUREMENT

The Values program has many fields of application. It can, for example, be used for measuring the straightness of foundations, shafts and bearing journals, as well as the centre of bores/bearings. Perfect for when you just want to see the readings, or when you want to measure in the same way as with dial indicators.

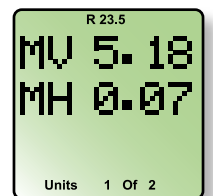
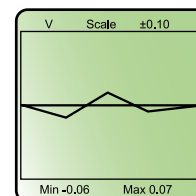
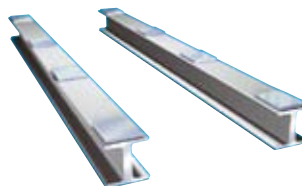

ROBUST DESIGN

Nothing has been spared when it comes to brackets that have proper chains and double rods for the measuring units, or other parts. All vital parts are also made from hard anodised aluminium or stainless steel for optimum corrosion resistance, and to guarantee consistent readings and optimum reliability even in the toughest environments.

Connectors well protected against external damage.



A keyboard with all characters accessible for easy naming of the measurements.

Carrying handle and rest.



Countersunk connectors, well protected against external damage.

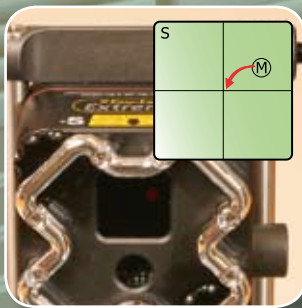

Electronic targets for adjustment of the laser beams to the detector centre.



Smooth design, no pockets where dirt or liquid can collect. Makes it easy to keep the measuring unit clean. The impact-absorbing frame also functions as a safety cover for the detector surface.



Unique, flexible design! Depending on available space, the measuring unit can be mounted at the front or the back on the shaft bracket.

ACCESSORIES

(The accessories are not approved for use in ATEX/EX environments. Also note that magnets and steel parts in the brackets listed below are not stainless.)

MAGNETIC FIXTURES

Bracket for axial mounting on flange or shaft.

Part No.: 12-0038



SLIDING FIXTURE

Used when the shafts cannot be rotated.

Part No.: 12-0039



THIN SHAFT BRACKET (12 mm)

This is used, for example, when there is limited space between the coupling and machine. Part No.: 12-0037



MAGNET BASE

For direct fixing to shaft or flange.

Part No.: 03-0013



CARDAN FIXTURE

Part No.: 12-0125



PRINTER

Thermal printer with cable and charger.

NB! Not ATEX approved.

Part No.: 03-0032



REAR FIXING HOLE

Fixing hole on the rear of the measuring units, for example, for attaching the machine spindle.

Also used for attaching the cardan fixture.

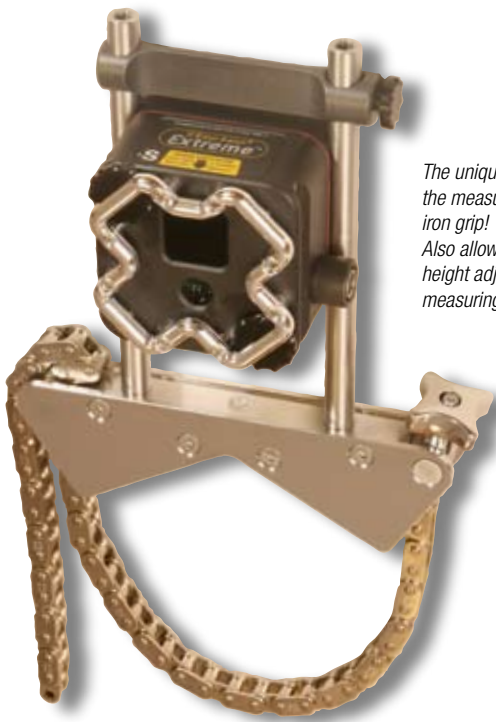

*The unique lock lever locks the measurement unit in an iron grip!
Also allows rapid and easy height adjustment of the measuring unit.*

SHAFT BRACKETS

Stable shaft brackets and chains made of stainless steel for optimum measurement stability.

The measuring units and chains are pre-mounted on the brackets for rapid set-up on the machine. Also reduces the risk of parts being lost.

CARRYING CASE

Strong case with aluminium frame and impact-absorbing lining. As the case is made of metal and has a conductive lining, it can be taken into explosive environments.



SYSTEM D550

Part No. 12-0340

- 1 Display unit D336
- 2 Cables with Push/Pull connectors, L=2m
- 2 Extra cables with Push/Pull connectors, L=2m, 5m
- 2 Measuring units (S: D335, M: D334)
- 2 Shaft brackets with chains
- 2 Extension chains
- 8 Rods
- 1 Manual
- 1 Measuring tape
- 2 Sets of batteries for the display unit
- 1 EasyLink™ Windows® program plus PC cable and USB adapter *PC program included!*
- 1 Carrying case with shock-absorbing lining. (Drop tested.)

TECHNICAL SPECIFICATIONS
System

EX classification	EEx ib IIC T4, ATEX code II 2G
EX certificate number	Nemko 06ATEX1051X
Warranty	48 months
Data transfer	Windows® EasyLink™ program (included)
Measurement range	Up to 20 m (shaft alignment)
Temperature range	0-40 °C
Relative humidity	10-95%
Max. displayed error	±1% +1 digit
Carrying case	WxHxD: 490x350x200 mm (Drop tested)
Weight (complete system)	12 kg

Measuring units (S, M)

Type of laser	Diode laser
Laser wavelength	635-670 nm, visible red light
Laser safety class	Class 2
Laser output power	< 1 mW
Resolution	0.001 mm <i>High resolution!</i>
Type of detector	2-axis PSD 20x20 mm
Inclinometers	Electronic inclinometers, 0.1° resolution
Thermal sensors	±1°C accuracy
Protection	No influence from ambient light
Protection	IP67: Shockproof, Waterproof, Dustproof
Housing material	Hard anodised aluminium
Dimensions	WxHxD: 75x65x52 mm
Weight	220 g

Display unit

Type of display	Dot matrix LCD
Display size	73x73 mm
Displayed resolution	Changeable: 0.1; 0.01; 0.001 mm. 5; 0.5; 0.05 mils/thou
Battery	4 Duracell Procell Alkaline Mn1400 LR14 1.5 V
Operating time	20 hours continuously
Output port	RS232 with USB adapter. For printer and PC communication
Keyboard	Membrane keys with alphanumeric multifunction
Storage memory	Space for 1,000 shaft alignment measurements <i>Large memory!</i>
Settings	For Measurement value filtering, Unit (mil/thou/mm) etc.
Protection	IP67: Shockproof, Waterproof, Dustproof
Housing material	Anodised aluminium/Chrome-plated aluminium
Dimensions	WxHxD: 177x180x43 mm
Weight	1,000 g

Shaft brackets

Bracket	V-bracket for chain, width 18 mm
Material	Stainless steel (also chains)
Shaft diameter	∅ 20-450 mm with standard chains
Weight	800 g

Rods

Material	Stainless steel
Length	140 mm (extendable to 280 mm)

Cables

Type	With Push/Pull connectors
Length	3x2 m, 1x5 m

ATEX / IP67 / CE / EXTENDED GUARANTEE

Easy-Laser® Extreme™ is approved in accordance with the latest ATEX directive for intrinsically safe equipment. ATEX code: II 2 G, EX classification: EEx ib IIC T4. EX certificate number: Nemko 06ATEX1051X



Easy-Laser® Extreme™ is waterproof, dustproof and shockproof. The instrument has been tested and approved in accordance with *Ingress Protection Rating System* IP67, which means that the system is dustproof and waterproof to a depth of 1 metre.



Damalini AB's quality system is approved by Nemko (Notification Number Nemko 05ATEX44280) as follows: "Nemko AS, notified body number 0470 for Annex VII in accordance with Article 9 of Council Directive 94/9/EC of March 1994 notifies to the applicant that the actual manufacturer has a product quality system which complies with Annex VII of the Directive." This guarantees top product quality. Therefore we dare to offer what is probably the longest guarantee period on the market, 4 years, on our Easy-Laser® Extreme™ systems*.



All precision instruments require calibration at certain intervals. The Easy-Laser® Extreme™ system comes with one free calibration within two years of the date of purchase*.

(*Full terms for guarantee and service commitments can be found at www.damalini.com).

Easy-Laser® is manufactured by Damalini AB, Åbäcksgatan 6B, SE-431 67 Mölndal, Sweden, Phone +46 31 708 63 00, Fax +46 31 708 63 50, e-mail: info@damalini.se, www.damalini.com
 © 2006 Damalini AB. We reserve the right to make changes without prior notification.
 Easy-Laser® and Extreme® are registered trademarks of Damalini AB.
 Windows® and Excel® are registered trademarks of the Microsoft Corporation.

Authorised dealer



This product complies with:
 SS-EN60825-1-1994,
 21CFR 1040.10 and 1040.11



05-0287